

GARY-Connector to Mainboard

GARY-Socket

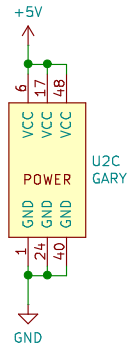
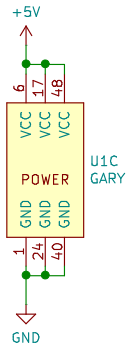
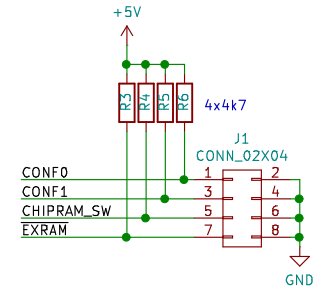
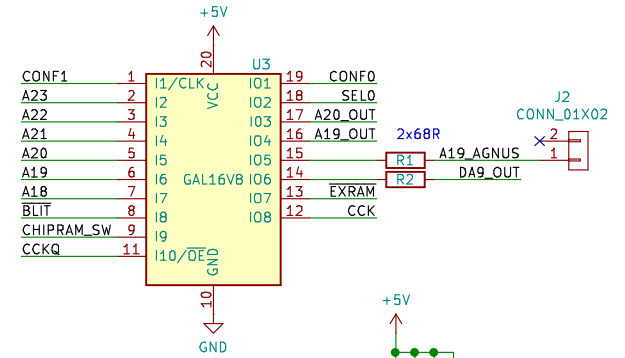
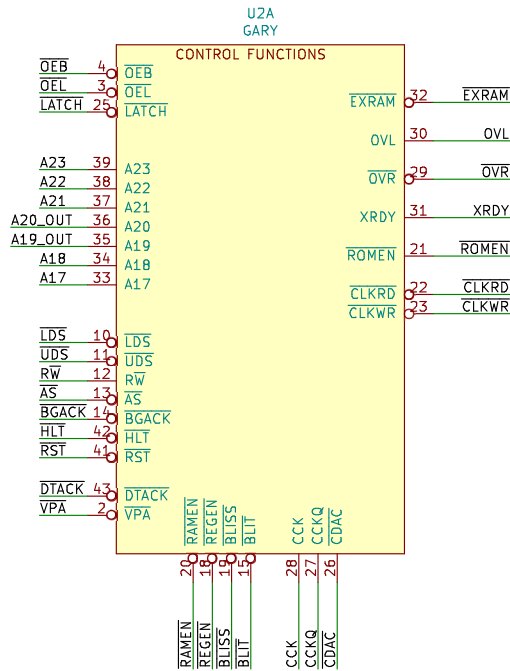
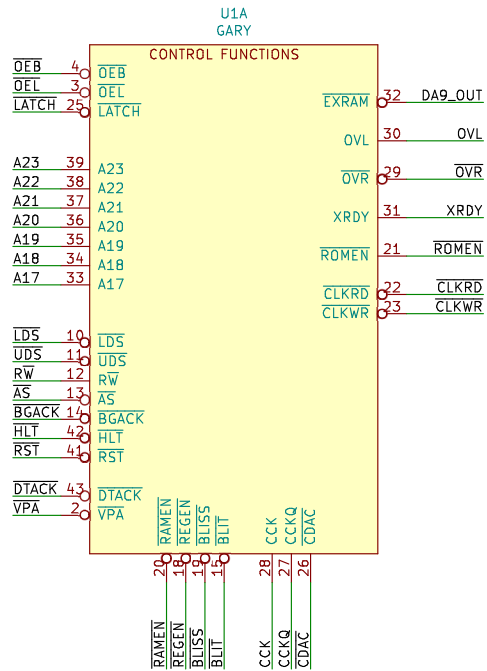
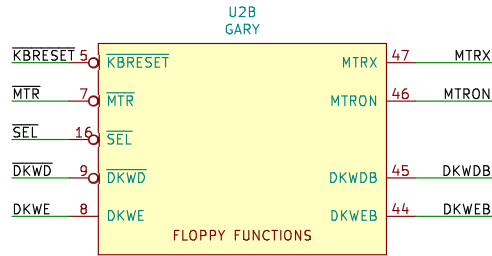
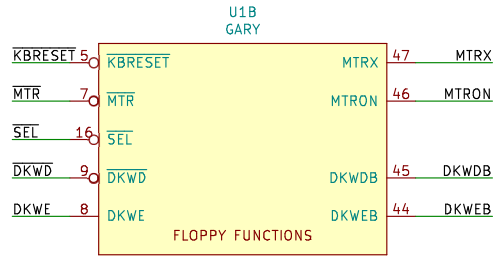

| | |
|-------------------------------------------------|----------|
| Sheet: / | |
| File: pcb-gary-ext.sch | |
| Title: | |
| Size: A4 | Date: |
| KiCad E.D.A. kicad 5.1.5-52549c584ubuntu19.10.1 | Rev: 1/1 |