

GARY-Connector to Mainboard

GARY-Socket

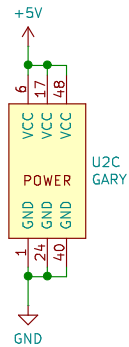
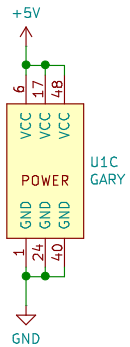
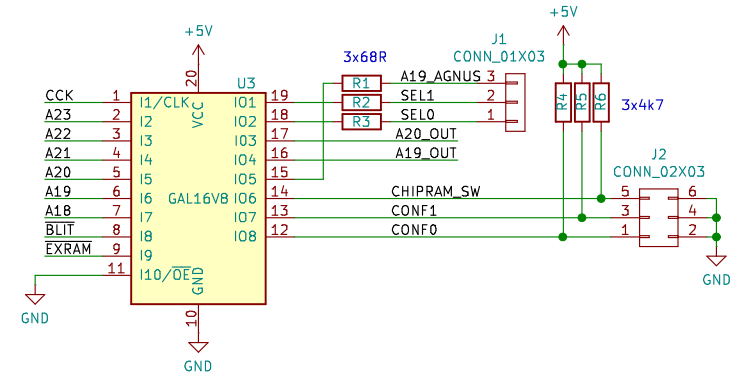
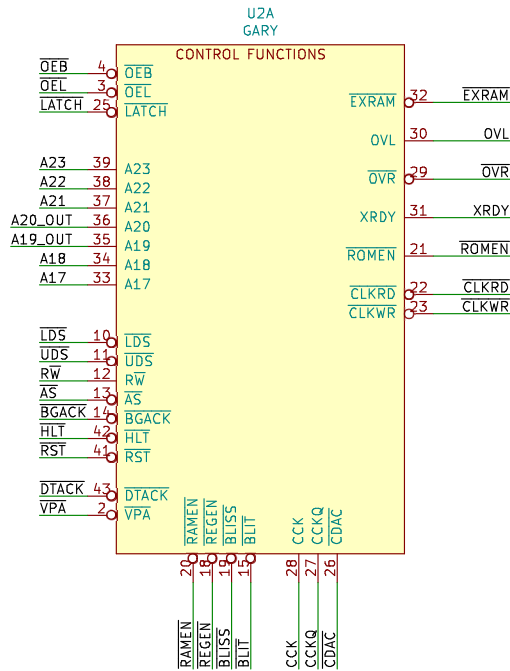
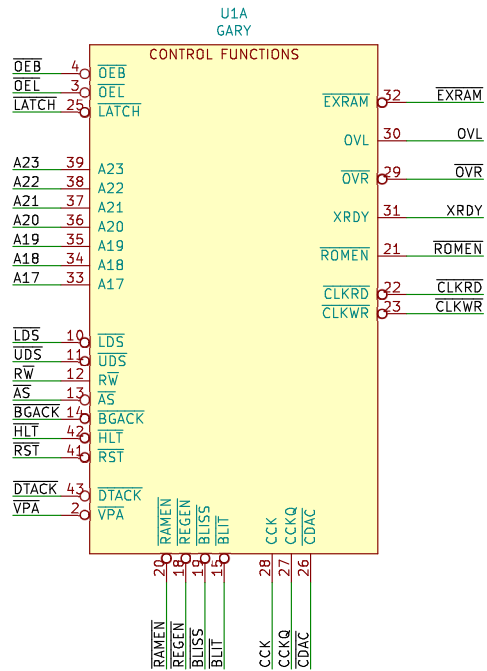
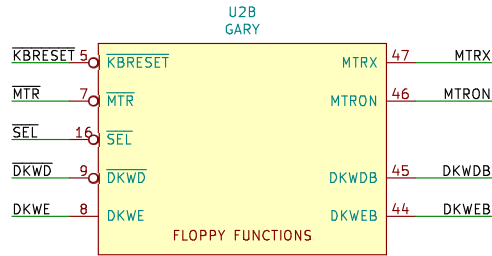
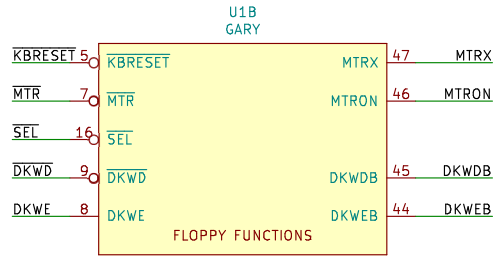

Sheet: /	
File: pcb-gary-sel.sch	
Title:	
Size: A4	Date:
KiCad E.D.A. kicad 5.1.5-52549c584ubuntu19.10.1	Rev: Id: 1/1